

Pola (PoII)

CHROME // 1180 x 500

Zawór termostaticzny 50 mm w osi, lewy + Głowica termostaticzna Noble // Sterownik KTX 2

CLASSIC







Podłączenie:

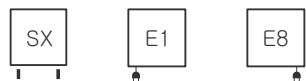

Dostępne na życzenie (+50 PLN):

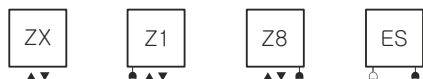

Dostępne warianty:

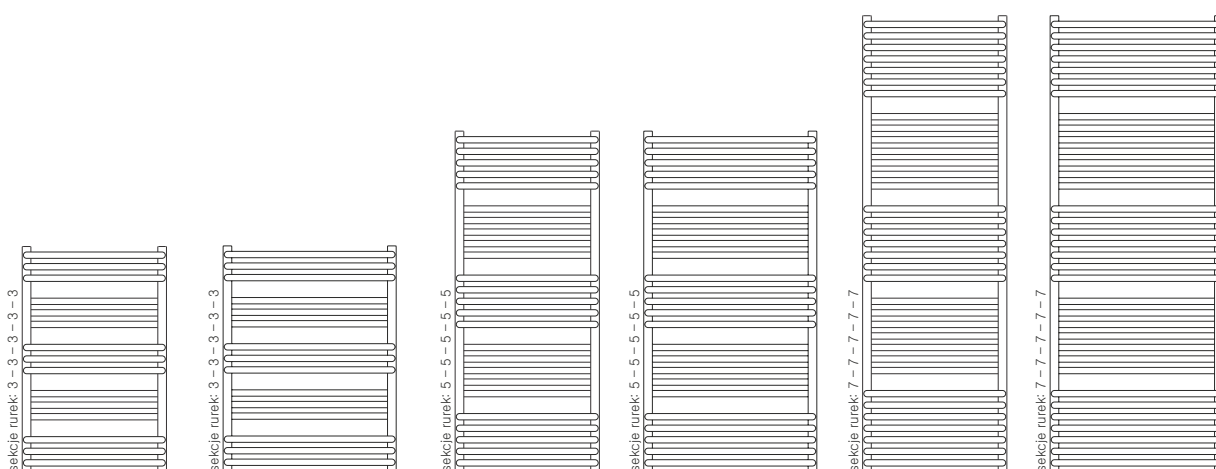

A	B	C	C'	75° 65° 20°	55° 45° 20°		D	E	F			CENA netto kolor standard [PLN]	CENA netto kolor specjalny [PLN]	KOD KARTOTEKI
[mm]	[mm]	[mm]	[mm]	[W]	[W]	[W]	[mm]	[mm]	[mm]	[dm³]	[Kg]			
780	500	470	50	392	200	400	470	600	90	3,3	6,7	415,00	518,75	WGPAL078050
780	600	570	50	471	240	400	570	600	90	3,8	7,7	445,00	556,25	WGPAL078060
1180	500	470	50	638	326	600	470	1000	90	5,4	10,8	555,00	693,75	WGPAL118050
1180	600	570	50	766	391	800	570	1000	90	6,1	12,4	605,00	756,25	WGPAL118060
1580	500	470	50	883	451	800	470	1400	90	7,4	15,0	665,00	831,25	WGPAL158050
1580	600	570	50	1061	541	1000	570	1400	90	8,5	17,2	770,00	962,50	WGPAL158060

Wersja chrom

780	500	470	50	274	140	300	470	600	90	3,3	6,7	1529,00	—	WGPAL078050
780	600	570	50	330	168	300	570	600	90	3,8	7,7	1649,00	—	WGPAL078060
1180	500	470	50	447	228	400	470	1000	90	5,4	10,8	1899,00	—	WGPAL118050
1180	600	570	50	536	274	600	570	1000	90	6,1	12,4	2049,00	—	WGPAL118060
1580	500	470	50	618	315	600	470	1400	90	7,4	15,0	2699,00	—	WGPAL158050
1580	600	570	50	743	379	800	570	1400	90	8,5	17,2	2899,00	—	WGPAL158060

Kolory standardowe: biały (RAL 9016), chrom.

Czas dostawy: grzejniki w kolorach standardowych o podłączeniu SX – 3 dni,

grzejniki w kolorach niestandardowych – 10 dni,

grzejniki chromowane – 3 dni lub do 4 tygodni (tel. +48 58 694 05 05).

Grzejniki elektryczne: strona 186

SX

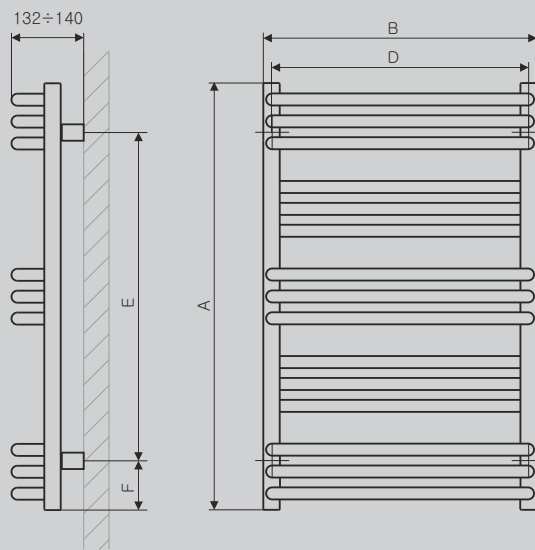
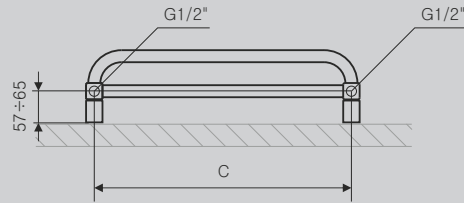

ZX

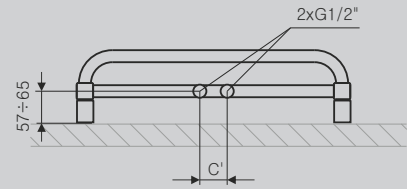

Z1

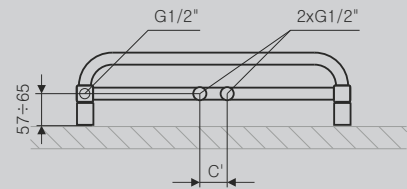

Z8

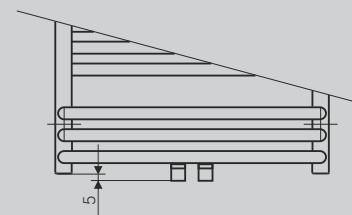
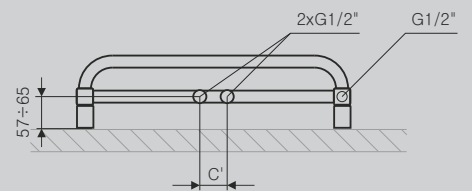

Profile

