

Intra

RAL 4005 // 1700 x 410

Zawór termostaticzny 50 mm w osi, prawy + Głowica termostaticzna Slim // Wieszak ZIP V 20

LUX

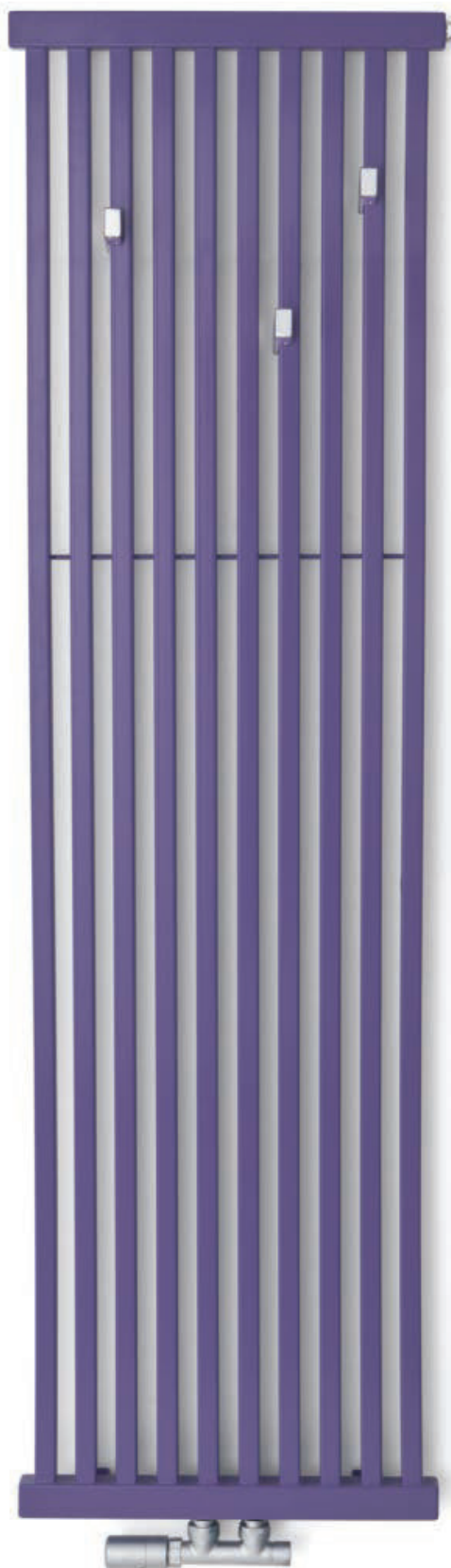



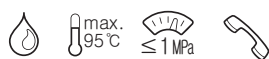

Podłączenie:



Dostępne warianty:

wersja bez lustra

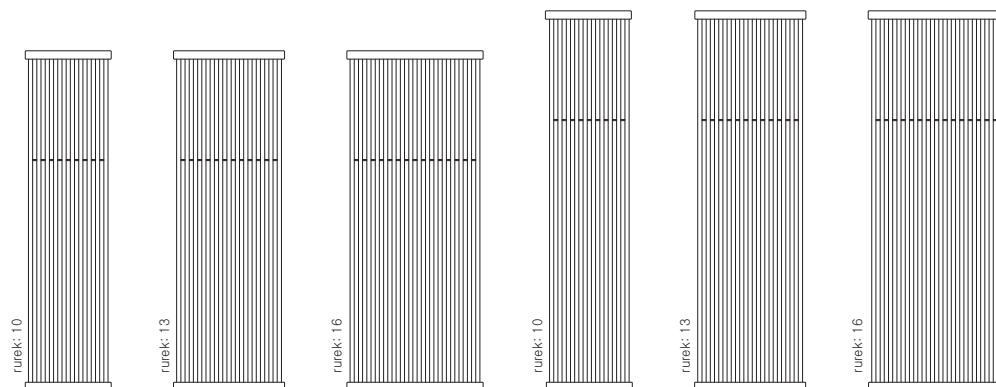

wersja z lustrem

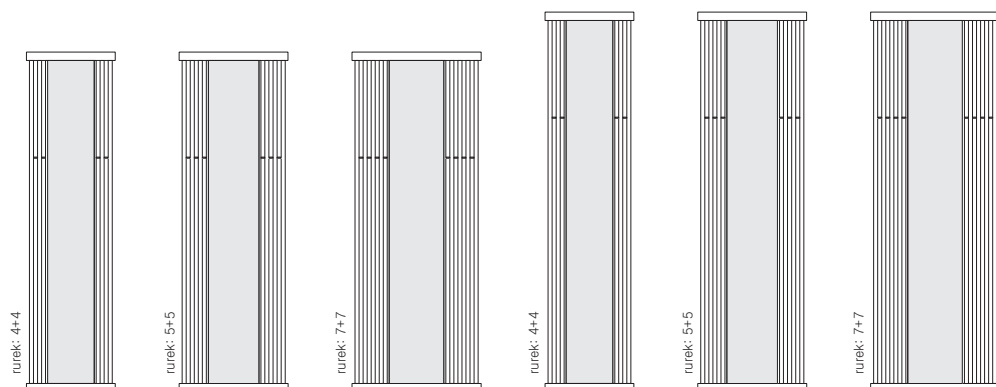

A	B	C	C'	C''	75° 65° 20°	55° 45° 20°		D	E	F			CENA netto kolor standardowy [PLN]	KOD KARTOTEKI
[mm]	[mm]	[mm]	[mm]	[mm]	[W]	[W]	[W]	[mm]	[mm]	[mm]	[dm ³]	[Kg]		

wersja bez lustra

1700	410	50	370	410	678	346	—	270	1660	20	4,6	13,1	1450,00	WGINB170041
1700	530	50	490	530	864	441	—	390	1660	20	5,7	16,2	1550,00	WGINB170053
1700	650	50	610	650	1041	531	—	510	1660	20	7,8	22,1	1700,00	WGINB170065
1900	410	50	370	410	711	363	—	270	1860	20	7,7	14,4	1550,00	WGINB190041
1900	530	50	490	530	904	461	—	390	1860	20	8,8	17,9	1650,00	WGINB190053
1900	650	50	610	650	1089	556	—	510	1860	20	10,9	24,5	1810,00	WGINB190065

wersja z lustrem

1700	440	50	400	440	549	280	—	300	1660	20	5,5	15,5	1750,00	WGINT170044
1700	540	50	500	540	683	349	—	400	1660	20	7,1	20,1	1850,00	WGINT170054
1700	640	50	600	640	925	472	—	500	1660	20	8,7	24,6	1990,00	WGINT170064
1900	440	50	400	440	600	306	—	300	1860	20	6,1	17,2	1850,00	WGINT190044
1900	540	50	500	540	762	389	—	400	1860	20	7,9	22,2	1950,00	WGINT190054
1900	640	50	600	640	995	507	—	500	1860	20	9,7	27,3	2110,00	WGINT190064

Kolory standardowe: 191 kolorów RAL oraz paleta barw Termy bez chromu.
Czas dostawy: do 10 dni roboczych.

P2

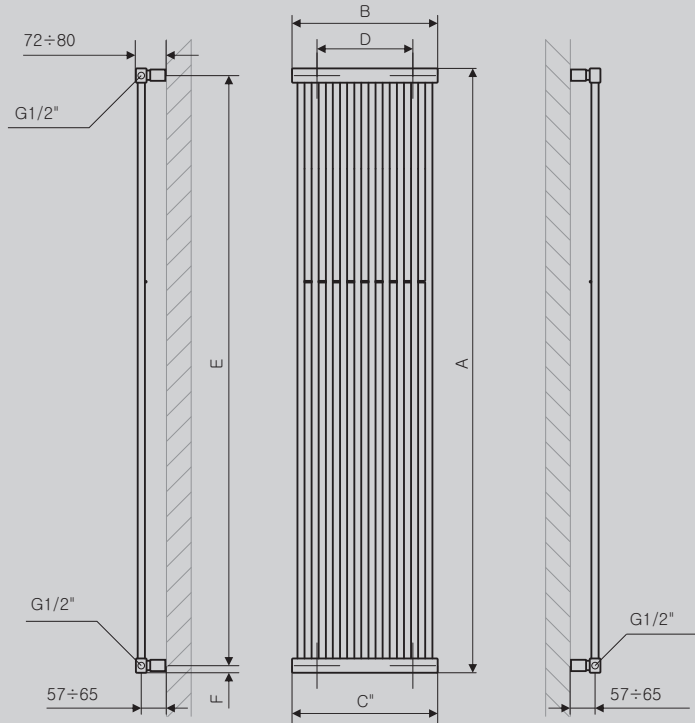

ZX

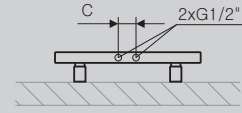

SX

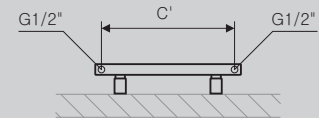

YL

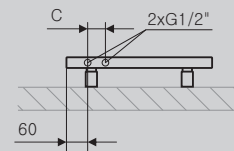

YP

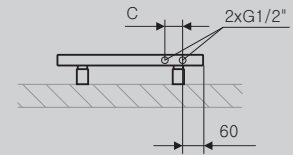

Profile

