

# Dexter

CHROME // 1220 x 500

Zestaw termostatyczny zaworów Dexter z gwintem zewnętrznym, lewy // Głowica termostatyczna Slim

MODERN



DESIGN: Dariusz Berus, Daniel Dawidowski





Podłączenie:

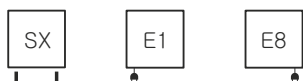

Dostępne na życzenie (+50 PLN)

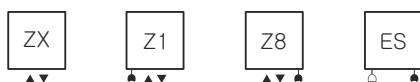

Dostępne warianty:

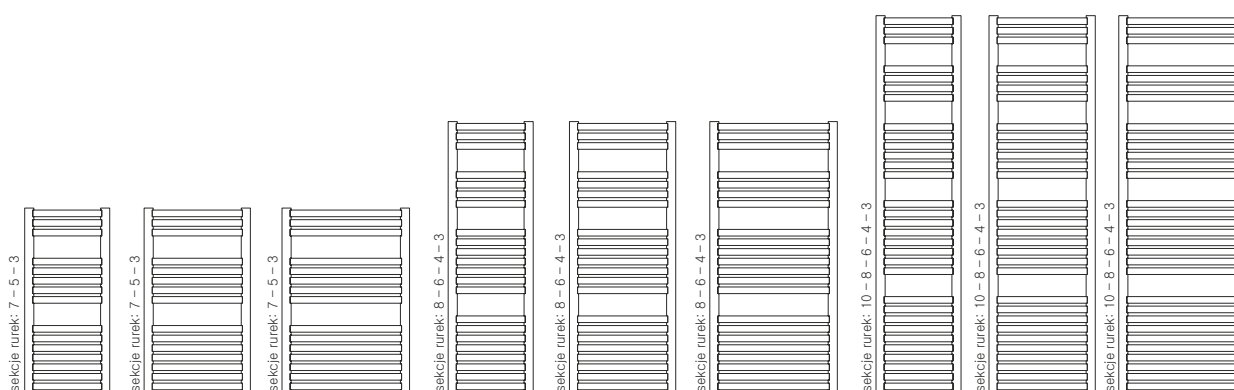

A	B	C	C'	75° 65° 20°	55° 45° 20°		D	E	F			CENA netto kolor standard [PLN]	CENA netto kolor specjalny [PLN]	KOD KARTOTEKI
[mm]	[mm]	[mm]	[mm]	[W]	[W]	[W]	[mm]	[mm]	[mm]	[dm³]	[Kg]			
860	400	357	50	368	188	400	350	680	90	2,7	7,1	520,00	650,00	WGDEX086040
860	500	457	50	439	224	400	450	680	90	3,0	8,4	540,00	675,00	WGDEX086050
860	600	557	50	510	260	600	550	680	90	3,3	9,6	565,00	706,25	WGDEX086060
1220	400	357	50	488	249	600	350	1040	90	3,8	9,9	630,00	787,50	WGDEX122040
1220	500	457	50	582	297	600	450	1040	90	4,2	11,7	660,00	825,00	WGDEX122050
1220	600	557	50	676	345	800	550	1040	90	4,6	13,5	700,00	875,00	WGDEX122060
1760	400	357	50	697	356	800	350	1580	90	5,6	14,4	880,00	1100,00	WGDEX176040
1760	500	457	50	833	425	800	450	1580	90	6,1	17,1	920,00	1150,00	WGDEX176050
1760	600	557	50	971	495	1000	550	1580	90	6,7	19,7	970,00	1212,50	WGDEX176060

Wersja chrom

860	400	357	50	244	124	300	350	680	90	2,7	7,1	1350,00	-	WGDEX086040
860	500	457	50	288	147	300	450	680	90	3,0	8,4	1425,00	-	WGDEX086050
860	600	557	50	337	172	300	550	680	90	3,3	9,6	1537,00	-	WGDEX086060
1220	400	357	50	328	167	300	350	1040	90	3,8	9,9	1875,00	-	WGDEX122040
1220	500	457	50	387	197	400	450	1040	90	4,2	11,7	1950,00	-	WGDEX122050
1220	600	557	50	447	228	400	550	1040	90	4,6	13,5	2100,00	-	WGDEX122060
1760	400	357	50	488	249	600	350	1580	90	5,6	14,4	2300,00	-	WGDEX176040
1760	500	457	50	583	297	600	450	1580	90	6,1	17,1	2400,00	-	WGDEX176050
1760	600	557	50	680	347	600	550	1580	90	6,7	19,7	2600,00	-	WGDEX176060

Kolory standardowe: biały (RAL 9016), chrom, Silver Matt.

Czas dostawy: grzejniki w kolorach standardowych o podłączeniu SX – 3 dni,

grzejniki w kolorach niestandardowych – 10 dni,

grzejniki chromowane – 3 dni lub do 4 tygodni (tel. +48 58 694 05 05)

Grzejniki elektryczne: s. 186

SX

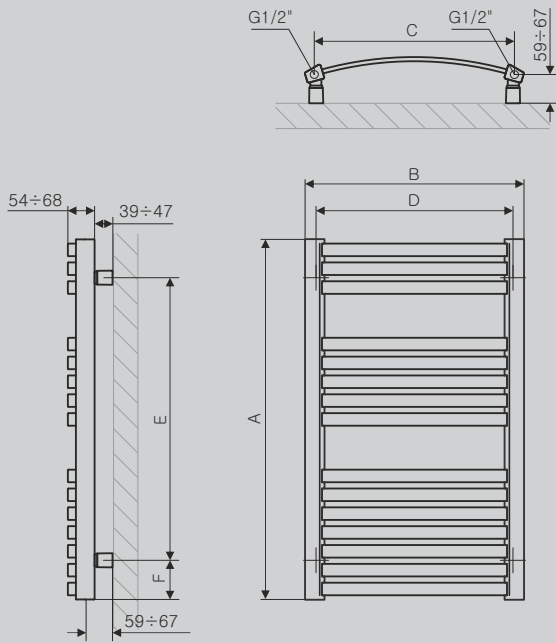

ZX

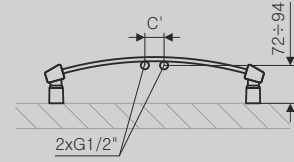

Z1

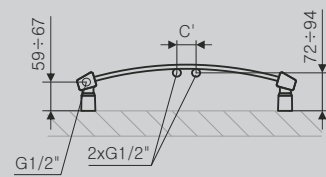

Z8

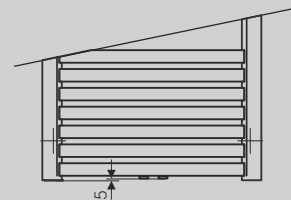
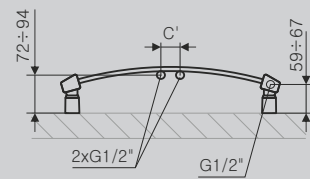

Profile

